

MICROBASS

Series III

OWNERS MANUAL



MB150E



MB150S



MB150E/112



MB150S/112

GK GALLIEN-KRUEGER

Congratulations

Your purchase of a new Gallien-Krueger MicroBass-III Series Amplifier is surely the result of much careful consideration on your part. For our part, we at Gallien-Krueger are pleased that you chose us and are confident that you will be a satisfied customer. In choosing an MB Series product, you own a unit with many unique features, which will allow you to create your own distinct sound.

To get the most out of your new purchase please take a few minutes to read through this manual. If you are in a hurry, we suggest you at least read through the Quick Start and Safety Information sections before setting up your new rig. This will help get you started and give you a few quick tips, but is not a substitute for reading the rest of the manual.

Your amplifier should have come with the following items, please check the contents of the box to ensure that you have everything.

Included with your MB Series product:

Power Cord	1
Owner's Manual	1
Warranty Card	1
Safety Instructions Sheet	1

Table Of Contents

Safety Information	3
GK Philosophy	4
Setup & Quickstart	5
Front Panel Controls	6
Rear Panel Controls	7
Internal/External Speakers	7
Sample Settings	8
Sound Advice	9
Tech Talk	10
Specifications	12

Warning!

Our amplifiers are capable of producing high sound pressure levels. Continued exposure to high SPL's can cause damage to your hearing. Always set the volume at a safe listening level or use hearing protection if the unit is operated at higher levels.



CAUTION
RISK OF ELECTRIC SHOCK
DO NOT OPEN



CAUTION: TO REDUCE THE RISK OF ELECTRIC SHOCK, DO NOT REMOVE COVER (OR BACK). NO USER-SERVICEABLE PARTS INSIDE. REFER SERVICING TO QUALIFIED SERVICE PERSONNEL.



The lightning flash with arrowhead symbol, within an equilateral triangle, is intended to alert the user to the presence of uninsulated "dangerous voltage" within the product's enclosure that may be of sufficient magnitude to constitute a risk of electric shock to persons.



The exclamation point within an equilateral triangle is intended to alert the user to the presence of important operating and maintenance (servicing) instructions in the literature accompanying the appliance.

WARNING: TO REDUCE THE RISK OF FIRE OR ELECTRIC SHOCK, DO NOT EXPOSE THIS APPLIANCE TO RAIN OR MOISTURE.

CAUTION: TO PREVENT ELECTRIC SHOCK, MATCH WIDE BLADE OF PLUG TO WIDE SLOT, FULLY INSERT.
ATTENTION: POUR EVITER LES CHOCS ELECTRIQUES, INTRODUIRE LA LAME LA PLUS LARGE DE LA FICHE DANS LA BORNE CORRESPONDANTE DE LA PRISE ET POUSSER JUSQU'AU FOND.

Safety Information

Please read all enclosed safety precautions, before connecting or operating this product.

Verify Line Voltage and Amperage Before Use:

Your new MicroBass Series amplifier has been factory configured for use with:

- 120 Volt/60Hz 15 A circuit for USA/Canada.
- 230 Volt/50Hz 10 A circuit for UK/Australia.
- 240 Volt/50Hz 10 A circuit for Europe.
- 100 Volt/50Hz 15 A circuit for Japan.
- 220 Volt/50Hz 10 A circuit for Korea.

Connecting the amplifier to a line with specifications other than indicated above can create a safety or fire hazard and may damage the amplifier. If you have any questions about the voltage requirements for your specific model, or about the line voltage in your area, contact your dealer before plugging the unit into a wall outlet.

Verify AC Circuit Capacity Before Use:

The high power output of your amplifier may require heavy current draw under full-load conditions. To insure proper performance and avoid potential safety hazards, we recommend connection to line circuits with amperage specified "as above". Connecting multiple amplifiers to the same circuit, or connecting the amplifier to the same circuit used by other heavy-power devices, such as high-wattage lights, may cause circuit breakers to trip. It is always a good idea to avoid using any audio equipment on the same AC circuit as equipment with motors, such as air conditioners or refrigerators. This will lessen the possibility of power variation and electrical start-up noise affecting your sound.

AC Power Cord:

To avoid safety hazards, use only the power cord supplied with your unit. If a replacement cord is needed, make certain that to use a standard IEC compliant cord. Damaged power cords should be replaced immediately.

Connecting to AC Power:

When setting up, make certain that the AC plug is easily accessible. If mounting in a rack, ensure that the AC mains can be easily disconnected by a plug or by an all-pole disconnect switch on or near the rack.

Disconnect When Not In Use:

If you do not intend to use the amplifier for a considerable length of time, disconnect the plug from the AC outlet. Just switching the unit off does not mean that it is fully disconnected from the AC Mains. To isolate the unit from the AC mains, you must disconnect the power cord from the unit and the AC outlet. When disconnecting the power cord always pull from the plug, never pull from the cord.

Do Not Open the Amplifier Enclosure:

There are no user-serviceable components inside this product. Opening the amplifier enclosure may present a shock hazard, and modification to the product will void your warranty. If liquid enters the unit, or any metal object such as a paper clip, wire, or staple accidentally falls inside the enclosure, disconnect the unit from the AC power source immediately and consult an authorized service station.

Unpacking:

The carton and packing materials used in shipping your new amplifier were specifically designed to cushion it from the shocks and vibration that occur during transport. We suggest that you save the carton and packing materials for use in shipping, in the event you move, or the amplifier needs repair.

GK Philosophy

I have never seen the point in doing things the way others have done them. I also have not been very interested in following the latest fad. I am a Stanford educated engineer who worked his way through school as a musician. Like all musicians, I have lugged amplifiers up stairways and into car trunks, always wondering why these things had to be so heavy, bulky, and hard to handle.

As I am the principal innovator at **GK**, our products reflect my attitudes and life experiences. I don't model my designs after other manufacturer's products (as some of our competitors are proud of reciting). Instead, I believe new and old problems are best solved with new solutions. Having taken our own path, **GK** products enjoy a unique, unmatched sound, allowing the artist using them every opportunity to make an original statement.

Having supported my products for over thirty years, I have learned from the story they tell. **Gallien-Krueger** is a reflection of that story, and has a commitment to support that legacy. Just as the products I created thirty years ago are still telling their story, the products we create today will be talking to us tomorrow.



Robert Gallien

Founder & President

If your MB Series amplifier or combo is missing any items, or if you encounter problems while setting up your new equipment, please contact your local dealer, or us as soon as possible at:

Gallien-Krueger, Inc.
2234 Industrial Drive
Stockton, CA 95206
phone: (209) 234-7300
fax: (209) 234-8420
Internet: www.gallien-krueger.com
Email: sales@gallien.com

We wish you a lifetime of good playing and remember to always have fun!

Setup & Maintenance

Setup:

To insure proper operation and to avoid potential safety hazards, place the unit on a firm, level surface. Do not plug or unplug the instrument or speaker cable while the amplifier power is on. Rack-mounting this unit is not recommended.

Heat & Ventilation:

For proper ventilation, make sure there is at least 8 inches (20cm) of clearance around the sides, top, back and front of the amplifier. Avoid using in extremely hot or cold locations and areas that are exposed to direct sunlight, or near heating equipment. The heat sink fins and ventilation slots that form part of the enclosure are specially designed to displace heat generated by the amplifier. Placing other electronic equipment near these heat-dissipation systems may possibly affect the long-term reliability of both your amplifier and the other equipment.

Moving the Unit:

Before moving the unit, be certain to disconnect all cables. Make sure that you disconnect the unit from the AC outlet. If Traveling with the unit frequently, we recommend a road case or gig bag to protect it from scratches and road wear.

Cleaning & Maintenance:

Clean only with a dry cloth. Never use benzene, thinner, alcohol, or other volatile cleaning agents. Do not use abrasive cleaners, as they may damage the finish of metal parts. Avoid spraying insecticides near the unit. No other maintenance should be necessary.

Quick Start

Plug It In:

Set the power switch to Off and connect the supplied power cord, from the amplifier's AC receptacle, to an AC power outlet of proper voltage and power rating (see safety information on page 3 for details).

Connect Your Cabinets:

Connect your external speaker cabinets to the amplifier outputs marked SPEAKER OUTPUTS. If you are using two 8 ohm or one 4 ohm external cabinet with an MB Series combo, turn the internal speaker off by pressing the switch out. Be sure not to exceed the recommended speaker load below.

Maximum Recommended Speaker Loads:

EXTERNAL SPEAKER(S)	INTERNAL SPEAKERS	TOTAL LOAD
1 x 8 ohms	on =	4 ohms
1 x 4 ohms	off =	4 ohms
2 x 8 ohms	off =	4 ohms

If you are using a Gallien-Krueger HMS (Horn Management System) compatible speaker cabinet, set the cabinet's bi-amp switch to Full Range.

Initial Front Panel Control Settings:

Set all EQ controls and the Boost control to 12 o'clock (The MBS does not have a boost control). The Voicing Filters should be turned all the way down to get a flat response. Set the Input and Master Volumes at 0.

Connect Your Bass:

Using an instrument (shielded) cable, connect your bass to the Input jack and press the power switch on.

Input and Master Volume Settings:

Set the master to 12 o'clock then gradually increase the preamp volume control to a comfortable listening level. If you hear distortion at low volume settings, try pressing in the -14dB pad. If it's still distorted, try turning the volume down on your bass.

Setup & Quick Start

MicroBass-III Series

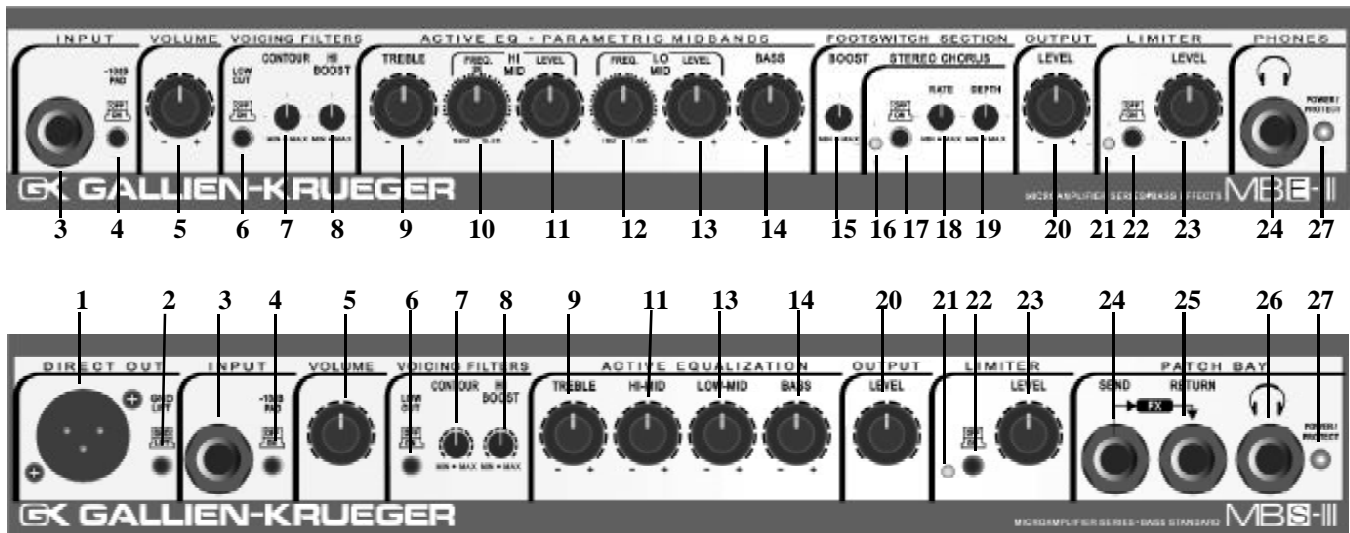

Front Panel Controls

- 1 Balanced Direct Out (MBS Only):** An electronically balanced low Z output. This is permanently set to Pre-EQ.
- 2 Ground/Lift (MBS Only):** This switch disconnects the ground on the balanced, XLR output to eliminate hum and buzz when connecting to equipment that is running on a different ground system.
- 3 Input:** A standard 1/4" input jack to plug in active or passive basses using an instrument (shielded) cable.
- 4 -14dB Pad:** Reduces the input signal from your bass. Press in if you hear distortion at low volume settings.
- 5 Volume:** Sets the preamp gain after the input stage.
- 6 Low Cut:** Rolls off the low end, producing a more "vintage" tone reminiscent of the GK 400B.
- 7 Contour:** Cuts midrange frequencies while boosting lows & highs. Center frequency is 500Hz.
- 8 Presence:** Adds edge and definition to higher frequencies.
- 9 Treble:** Boost and cut at 5 kHz +5dB/-22dB shelving type.
- 10 Hi Mid Frequency (MBE Only):** Sets the center frequency for the Hi Mid control between 620Hz and 6.2kHz.
- 11 Hi Mid:** Boost and cut at 2 kHz +10.5dB/-7dB, "Q Optimized," band pass type.
- 12 Lo Mid Frequency (MBE Only):** Sets the center frequency for the Lo Mid control between 160Hz and 1.6kHz.
- 13 Lo Mid:** Boost and cut at 500Hz +7.5dB/-10dB, "Q Optimized," band pass type.
- 14 Bass:** Boost and cut at 80Hz \pm 8.5dB, shelving type.
- 15 Boost (MBE Only):** Post EQ gain stage using GK's exclusive Valve Effect which adds "growl" as it is turned up. May be engaged with the RF2 Footswitch.
- 16 Stereo Chorus LED (MBE Only):** LED is lit when the Stereo Chorus is engaged.
- 17 Chorus On/Off Switch (MBE Only):** Turns the Stereo Chorus effect on. This switch is disabled when the RF2 Footswitch is used.
- 18 Chorus Rate (MBE Only):** Adjusts the speed of the Chorus effect.
- 19 Chorus Depth (MBE Only):** Adjusts the depth of the Chorus effect.
- 20 Output Level:** Controls the output level of the amplifier.
- 21 Limiter LED:** LED is lit when the Limiter is on.
- 22 Limiter On/Off:** Press in to turn the Limiter on.
- 23 Limiter Level:** Varies the power amp output from 20 watts to 150 watts. When using the limiter, start with the adjustment knob turned fully clockwise. Turn the knob counterclockwise to decrease distortion.
- 24 Effects Send (MBS Only):** For the insertion of effects after the EQ, but before the boost section. May also be used as a line out.
- 25 Effects Return (MBS Only):** When the Return jack is used, the Effects Loop is 'in series', meaning all of the signal goes through the Effects Loop.
- 26 Phones:** Stereo 1/4" output jack for private headphone listening.
- 27 Power/Protect LED:** The LED is red for five seconds while the amp powers up, then turns blue when the amp is ready. Should the amp experience a fault (over heat, over current) the amp will mute and the LED will switch to red until the condition is corrected.

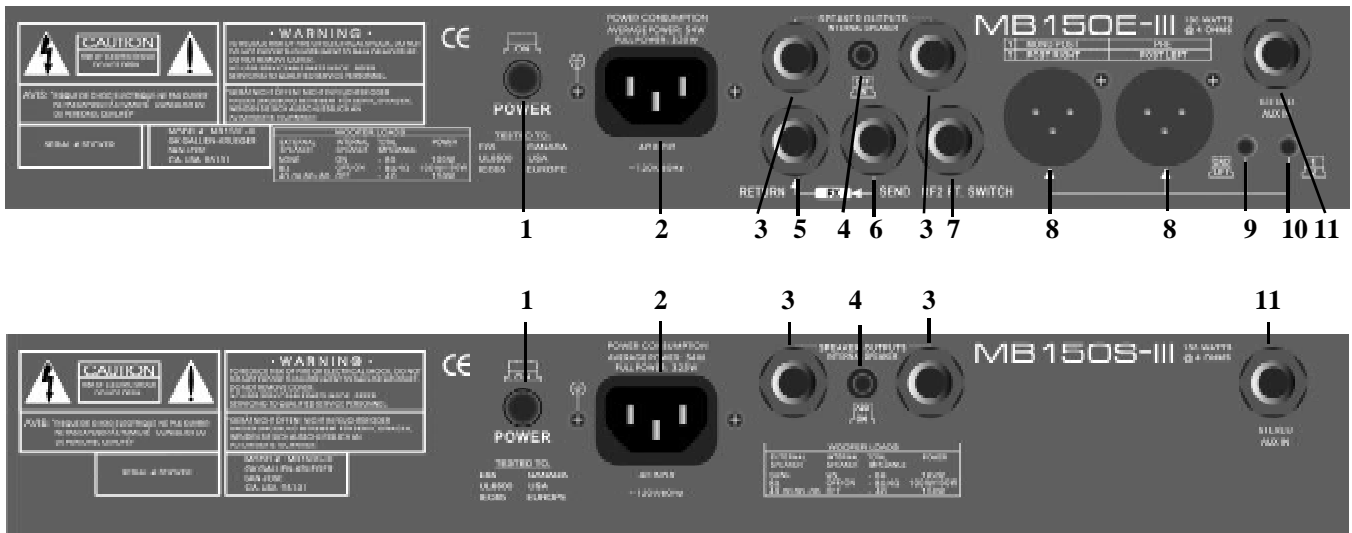

Rear Panel Controls

- 1 Power On/Off Switch:** Press in to turn the amplifier on, out to turn it off. Power/Protect LED is on when the amplifier is on.
- 2 AC Receptacle:** The power cord is detachable and plugs in here.
- 3 Speaker Output:** Power amp 1/4" jack outputs. It delivers 150W into 4 Ohms or 100W into 8 Ohms.
- 4 Internal Speaker On/Off Switch (Combo Only):** Turns the internal speaker off for private headphone listening or to allow the internal power amplifier to drive an external speaker load of 4 ohms.
- 5 Effects Return Jack (MBE Only):** When the Return jack is used, the Effects Loop is in series. All of the signal goes through the Effects Loop.
- 6 Effects Send Jack (MBE Only):** Send and return jacks provided for the insertion of effects after the EQ, but before the boost section.
- 7 Footswitch Jack (MBE Only):** Use the RF2 Footswitch to turn on/off the Boost and Chorus effects.
- 8 Direct Outputs (MBE Only):** A pair of electronically balanced low Z outputs, for sending a separate left and right mic level signal to a PA system. Pre/Post Switchable.
- 9 Ground/Lift (MBE Only):** This switch disconnects the ground on the balanced, XLR output to eliminate hum and buzz when connecting to equipment that is on a different ground system.
- 10 Direct Out Mode Switch (MBE Only):** When Mode 1 is selected, XLR Right is Mono Post and XLR Left is Mono Pre. When Mode 2 is selected, the Direct Outs are Post Left/Right for Stereo Chorus output.
- 11 Line Out:** Provides a line level signal (post Boost) for interfacing with outboard power amplifiers or an external DI Box.

Internal/External Speakers

The MB-III Series combos feature one 8 Ohm, 12" low resonance speaker, which delivers surprising low-end response and volume for it's size. While it works great for electric bass, the MB Series combo is particularly well suited for acoustic upright bass.

Driving External Cabinets:

The MB Series combo electronics are identical to the MB Series heads and are rated for the same maximum power output and speaker load (150W into 4 Ohms or 100W into 8 Ohms). Maximum power is achieved by connecting one 8 Ohm extension cabinet such as the 112MBX in addition to the combo's internal 8 Ohm speaker load. To drive more than one extension cabinet, the combo's internal speaker can be disconnected by pressing the Internal Speaker switch on the back panel. Below is a detailed description of the maximum loads the combos can drive.

Maximum Recommended Load:

Internal Speaker On:

One 8 Ohm extension cabinet.

Internal Speaker Off:

One 4 Ohm, or Two 8 Ohm extension cabinets.

MicroBass-III Series

sample settings

Pop

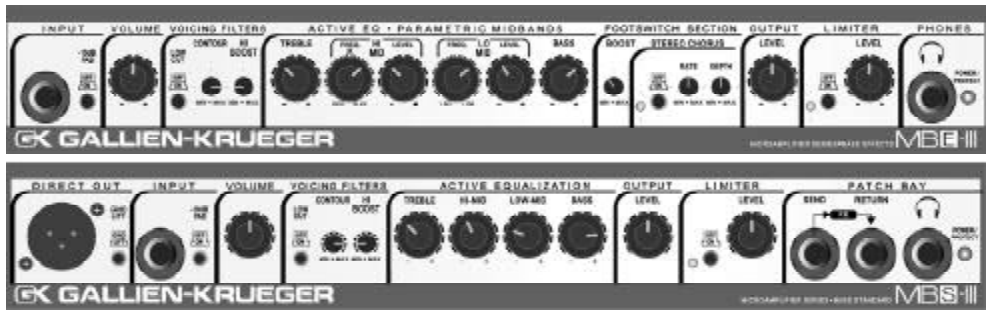

Walking Bass

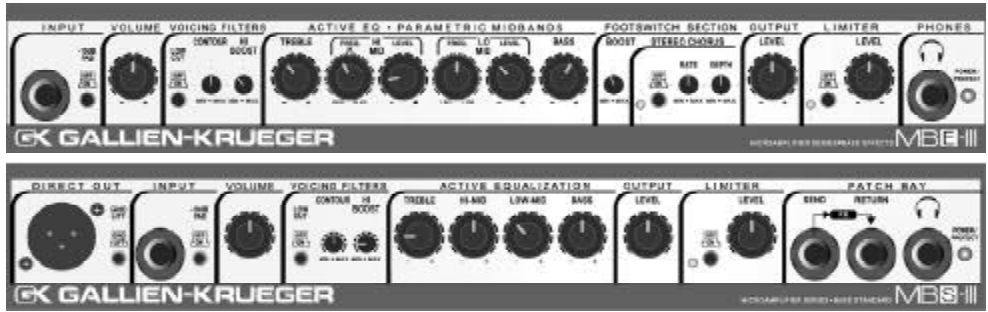

Slap
Limiter On

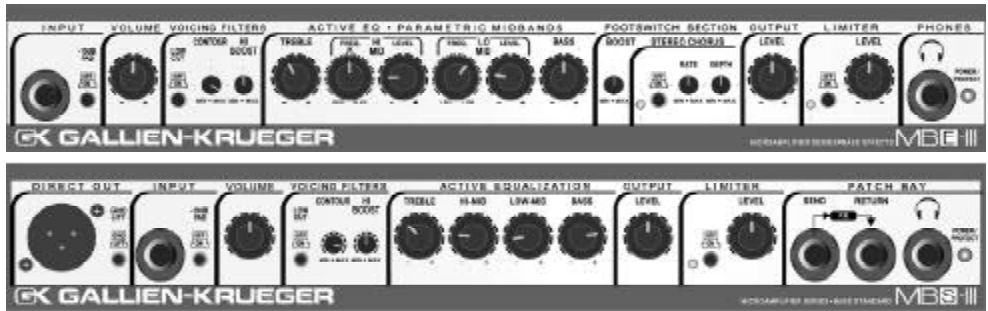

Fuzz Tone
Limiter On



Reggae
Limiter On



Acoustic Upright

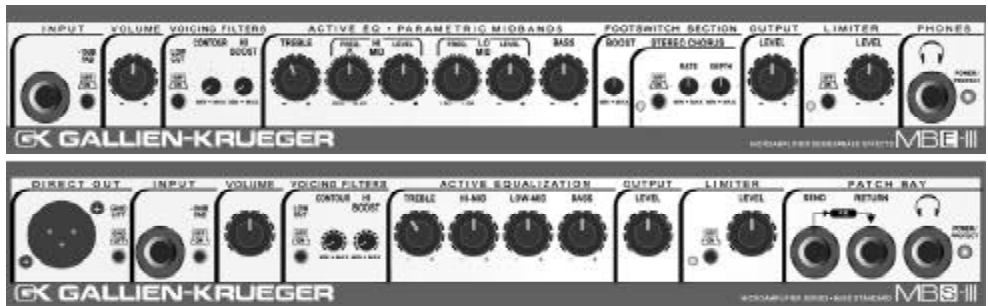

Sound Advice

Input Volume vs. Output Level:

The Input Volume adjusts the signal as it enters the preamp section. Changes to it will have an impact on the Send jack, Boost control, and the Direct Output if it is set to Post mode. Depending on the output signal from your bass, setting the volume below 1 o'clock produces a cleaner signal while setting it above 1 o'clock produces a subtle overdrive effect.

The Output Level adjusts the volume of the Internal Power Amplifier, after the preamp (Post EQ). For most playing situations, the Output Level is set between 12 and 3 o'clock. Set it above 3 o'clock for maximum power situations.

Note: Be careful not to overdrive the Internal Amplifier. This creates a square wave (fully clipped signal) which may cause damage to your speaker regardless of its power rating.

Contour:

Increasing the Contour level will scoop out midrange frequencies while boosting the highs and lows. The sound is unique to GK and unavailable on any other bass amp. Lower contour settings are recommended for midrange clarity at higher playing levels.

Presence:

The Presence control is great for slap style playing or if you need to add a little extra high-end sparkle to your tone. It's particularly useful if your strings are old and dull sounding.

Equalization:

The Equalizer is used to fine tune your sound. When changing the settings, try making only subtle adjustments at first. These are active circuits, and small changes can make a big difference.

Boost Control:

The Boost Control adjusts the Valve Effect (See Tech Talk for more info). Turning up the Boost will add a little growl to your tone. This is an unmistakable, highly sought after, GK trademark sound. Raising the Boost

While lowering the Master will add more growl while keeping the sound level relatively even. The 'growl' is actually a small amount of even order harmonic distortion. For most playing situations, start with the Boost at 12 o'clock. Reduce for a cleaner sound, or increase for more growl. When overdriving the Preamp, increase the Boost control to fatten up the tone.

Direct Out:

Your GK amplifier includes a low noise, high quality balanced Direct Out for connection to PA and recording consoles. The MBS is set for Pre EQ. The MBE has two Direct Outputs which can be set with one in Pre and one in Post simultaneously, or both in Post Stereo L/R to accommodate the built in stereo chorus. Both the MBE and the MBS include a Ground (Gnd) Lift switch to remove hum and buzz when connecting to equipment powered by a different ground system.

When in Pre Output mode, the signal is fed directly from our low noise, high headroom, FET input stage to the Direct Output. This provides a low noise output superior to external direct boxes and impedance transformers. Using Pre-Output mode, the Direct Output signal is only effected by the -14dB Pad and Tuning Mute controls. This allows you to adjust your tone and volume on stage without changing the Direct Output signal level.

Post-Output mode sends the fully effected preamp signal to the Direct Out. This gives you complete control over your Direct Out tone and volume and has the added benefit of really annoying the sound guy.

Tech Talk

MB Series Overview:

The MB Series is a flexible, state-of-the-art bass amplifier, designed to deliver maximum performance, and be simple to operate. This is accomplished through a few, very important features:

- High current capability for better speaker control.
- Four bands of active equalization for precise tone control.
- Robust voicing filters for shaping and customizing your sound.
- A high headroom gain stage for low noise operation.
- GK's proprietary Valve Effect for extra growl
- Class "H" design for better efficiency.
- Intelligent protection circuitry which constantly monitors for unsafe conditions.

High Current Capability:

When a power amplifier is pushing a speaker cone and it needs to reproduce a high-power transient like a string slap, the amp must be able to deliver a high current pulse to maintain cone control. If the amplifier can't do this it simply cuts the transient off, producing an unresponsive less out front sound. Creating these high current pulses requires extra power devices (four times the current required to deliver its rated power), larger supply capacitors, and intelligent protection logic. GK is the only bass amp manufacturer that goes to the trouble and expense to make this happen and it is a big reason why GK amplifiers sound louder and cleaner than other brands at the same power rating.

Active Equalization:

Standard tone controls and graphic equalizers give you plenty of variation, but they don't provide what the instrument really needs. In fact, graphic equalizers are intended for room equalization and make poor instrument equalizers. The GK equalizer reflects 30 years of development and refinement and is unique to the industry. Each section is a special circuit optimized to perform a Bass specific job in its operation range. These sections are wired in series so they add to one another without creating unmusical peaks or valleys. The result is an equalizer that is easy to use and sounds natural at any setting.

Voicing Filters:

Voicing filters are used to completely re-voice the amplifier in ways that an equalizer cannot. They are extreme filters enabling the amplifier to accommodate a wide variety of playing styles with the simplest adjustments.

- The Contour is based on the same contour circuit as the 800RB, but adds a variable control for precise tone shaping. With the control at zero, it matches the 800RB contour switch 'out' or off, and when turned all the way up, it matches the 800RB contour on. As the contour is increased, it scoops out the mid frequencies while emphasizing the lows and highs. Additionally it compensates to keep the overall playing volume constant. With it's variable control, the contour will accommodate everything from the smooth finger-style player (set flat or off), to the aggressive slap player (fully scooped).
- The Low Cut filter rolls off the low end early in the signal path (before the EQ) which works well for four string players going for a heavy rock stage sound where too much bass interferes with the room.
- The Presence control adds extra sparkle on the high-end for better clarity and 'openness' in your tone. This is particularly useful when soloing or playing chords.

Limiter:

When the upper level of an amplifier's usable dynamic range is exceeded, audible signal distortion will occur which can damage speakers. Reducing the volume would create more headroom, but also increases the signal to noise ratio. It is therefore necessary to keep the volume level as high as possible. This is accomplished by using a limiter. A limiter sets a ceiling called the 'threshold', which restricts peak signals from exceeding the threshold point, allowing you to play at a higher overall volume level with less noise and less risk of distortion. While more limiting means increased headroom, it can also rob the dynamic range from your signal. Be careful not to overdo it.

Low Noise Operation:

The MB-III Series uses a high gain, high headroom, low noise input stage. It has such a large dynamic range (60v p-p) that very few instruments can overdrive it. Even most basses with “active” electronics do not need to use the -14dB input pad. The benefit to you is less hiss and much less noise over all.

The Valve Effect:

As in all GK amplifiers, the MB-III Series preamp incorporates what we call the Valve Effect, or G.I.V.E.(Gate Induced Valve Effect). We use field effect devices with the gate biased in such a way that emphasizes the optimum harmonic content of the signal. Working in concert with our unique Four Band Active Equalizer, and three stage Voicing Filter Section, the Valve Effect produces a consistently pleasing bass tone.

Cool and Reliable Class “H” Design:

The MB-III uses a “dual rail” power supply (class H) that generates about half the heat of conventional amplifiers. Low output signals run off of a low voltage supply keeping the amp running cool. When the signal exceeds a certain level, the amp switches to its high voltage supply until the higher signal level drops back down. By using a Class ‘H’ power supply it eliminates the need for a fan. Convection cooling is used instead for completely silent operation in the studio or on-stage. This well thought out design helps make the MB-III the little amp with the big sound.

Intelligent Protection Circuitry:

The MB Series protection circuitry constantly monitors for unsafe operating conditions such as short circuits, miss-wired speaker cables, blown speakers, improper ventilation, and incorrect speaker configurations. In addition, protection is provided during power up/down. If the amplifier senses any unsafe operating conditions, the output signal is immediately muted and the power light changes from Blue to Red. The amplifier will remain muted until the fault is removed. If the protection circuit activates while playing, turn the amplifier off and check the speaker output. If the problem persists, contact GK directly for technical advice.

connections. Be sure that you are not exceeding the maximum recommended load described in this manual.

In Closing:

You should now have a thorough understanding of how your new MicroBass Series amplifier works and the advantages it offers in dialing in ‘your’ sound. We thank you for reading the Owner’s Manual and wish you the best of times! Please send us your comments via the web at www.gallien-krueger.com or email us at sales@gallien.com.

Block Diagram

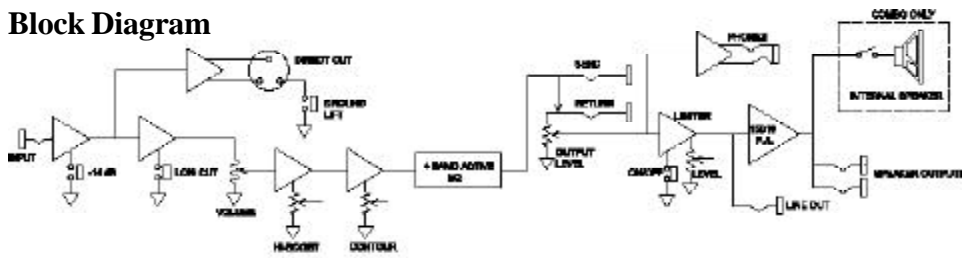

MB150S-III

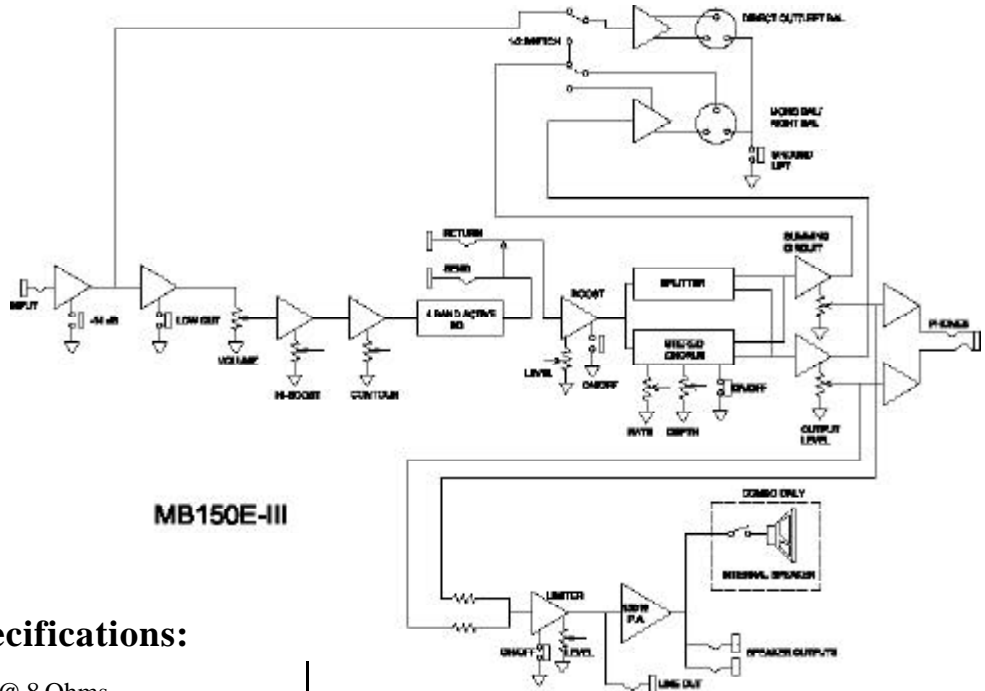

MB150E-III

MicroBass Series Specifications:

Output Power: 100W @ 8 Ohms
150W @ 4 Ohms

Input Section:
Maximum Input Level 0.45V Rms
With -14dB pad 2.0V Rms
Impedance 1M Ohm
Send output impedance 1k Ohm
Return impedance (MBE) 70k Ohm
Return impedance (MBS) 12k Ohm
Line Output Impedance 1k Ohm
Direct Output Impedance 500 Ohms

Equalizer:
Bass $\pm 8.5\text{dB}$ @ 80Hz
Lo-Mid $+7.5\text{dB}/-10\text{dB}$ @ 500Hz
(MBE Freq. Control: 160Hz-1.6kHz)
Hi-Mid $+6\text{dB}/-10\text{dB}$ @ 1kHz
(MBE Freq. Control: 620Hz-6.2kHz)
Treble $+5\text{dB}/-22\text{dB}$ @ 5kHz

Voicing Filters:
Low Cut 17.5dB @ 40Hz
Contour $+8.5\text{dB}$ @ 80Hz /
 -10dB @ 600Hz /
 $+10\text{dB}$ @ 8kHz
Presence $+13.5\text{dB}$ @ 2kHz

Noise -90db
Cooling: Convection Cooled

Amplifier Protection:
Full short circuit, thermal, & RF protection.
Stable into reactive and mismatched loads.
Five second muted warm-up.

Dimensions (HxWxD):
Head: 2.5" x 13.75" x 7"
Combo: 15.5" x 13.75" x 8.5"

Weight:
Head: 10 lbs.
Combo: 26 lbs.

Power Requirements:
U.S.A./Canada 120V/60Hz
325W(full power), 54W(average power)

UK/Australia 240V/50Hz
325W(full power), 54W(average power)

Europe 230V/50Hz
325W(full power), 54W(average power)

Japan 100V/50Hz
325W(full power), 54W(average power)

Korea 220V/50Hz
325W(full power), 54W(average power)